

See discussions, stats, and author profiles for this publication at: <https://www.researchgate.net/publication/309286039>

Handover Manageability and Performance Modeling in Mobile Communication Networks

Article · March 2014

CITATION

1

READS

27

1 author:



[Imeh Jonah Umoren](#)

Akwa Ibom State University

14 PUBLICATIONS 4 CITATIONS

[SEE PROFILE](#)

Some of the authors of this publication are also working on these related projects:



Artificial Intellience and Soft computing [View project](#)



Digital Transmision Networks [View project](#)

All content following this page was uploaded by [Imeh Jonah Umoren](#) on 18 June 2017.

The user has requested enhancement of the downloaded file.



HANDOVER MANAGEABILITY AND PERFORMANCE MODELING IN MOBILE COMMUNICATION NETWORKS

Imeh Umoren

Department of Computer Science
Akwa Ibom State University, Mkpato Enin
PMB. 1167, Akwa Ibom State, Nigeria
hollymeh_u@yahoo.com

Prince Oghenekaro Asagba PhD

Department of Computer Science
University of Port Harcourt
PMB 5323, Port Harcourt, Rivers State, Nigeria
pasagba@yahoo.com

Olumide Owolabi

Department of Computer Science,
University of Abuja, FCT, Abuja, Nigeria
doowolabi@yahoo.com

ABSTRACT

In cellular Networks, a mobile station (MS's) move from one cell region to another on seamless Communication scheduling.. Handoff or Handover is an essential issue for the seamless communication. Several approaches have been proposed for handoff performance analysis in mobile communication systems. In Code-Division Multiple-Access (CDMA) systems with soft handoff, mobile stations (MS's) within a soft-handoff region (SR) use multiple radio channels and receive their signals from multiple base stations (BS's) simultaneously. Consequently, SR's should be investigated for handoff analysis in CDMA systems. In this paper, a model for soft handoff in CDMA networks is developed by initiating an overlap region between adjacent cells facilitating the derivation of handoff manageability performance model. We employed an empirical modelling approach to support our analytical findings, measure and investigated the performance characteristics of typical communication network over a specific period from March to June, 2013 in an established cellular communication network operator in Nigeria. The observed data parameters were used as model predictors during the simulation phase. Simulation results revealed that increased system capacity degrades the performance of the network due to congestion, dropping and call blocking, which the system is most likely to experience, but the rate of those factors could be minimized by properly considering the handoff probabilities level. Comparing our results, we determined the effective and efficient performance model and recommend it to network operators for an enhanced Quality of Service (QoS), which will potentially improve the cost-value ratio for mobile users and thus confirmed that Soft Handoff (SH) performance model should be carefully implemented to minimize cellular communication system defects.

Keywords: CDMA, QoS, optimization, Handoff Manageability, Congestion, Call Blocking and Call Dropping, .

1. INTRODUCTION

Mobile Communication Networks are the fastest growing communications technology in history. This technology is largely attributed to the remarkable exploitation of cellular systems and the distribution of user's terminals. These efforts have tremendously increased the network capacity. The increase has resulted in frequent network defects that have challenge the proper functioning of the network, thus leaving some network operators with no option than to compromise quality. However, three stages must be accomplished to ensure the proper functioning of a network. These stages include: **planning, deployment and optimization**. The major causes of network defects lies in planning and deployment stages.



These two phases of network management determine the very Quality of Service (QoS) network operator likely to offer. However, with the introduction of newer technologies such as the third generation (3G) and Fourth generation (4G) technologies, network operators are expected to migrate easily to higher technologies. The case is not so with developing countries, which had successfully deployed the second generation (2G) technology.

The recent struggle by existing network operators to migrate to newer technologies and still offer reliable quality of service (QoS), has resulted in the planting of more cell sites (**mast or base stations**) and **site cloning** (attempts at upgrading the 2G network services to 3G services). This has resulted in severe network problems such as long response time/latency and not reachable terminals result from frequently congested networks and dropped calls. Some network operators often feed their subscribers by offering pre-ring back tunes instead of devising ways of solving the problems, which can only be achieved through the third phase of network management process known as **service optimisation**. Here, we concentrate on network issues related to mobile terminals (users) migrating from one coverage zone to another. The principle supervising this process is referred to as Handoff or Handover. Efficient handoff algorithm can enhance system capacity and reduce service cost. Code Division Multiple Access (CDMA) implements the soft handoff principle.

Soft handoff is a very fascinating technique used by Third generation (3G) networks. 3G networks apply the code division multiple access (CDMA) which has some well traditional benefits over previous handoff schemes. Efficient handoff management is a major determinant for reliable system performance. Successful and reliable handoffs are major issues for system performance. This research investigates handoff process of a well established CDMA network operating in Nigeria, from March to June, 2013. We analyzed the various parameters of the existing system and represent its performance in terms of QoS provisioning. A model is then proposed and simulated to improve the system through better procedures and methods. Finally, a comparison of the two systems is made to judge the resultant quality of service (QoS). In providing a method of managing the performance of handover in a cellular communication network, channel condition information is received from a mobile terminal (MT) attached to a serving base station (BS). Information is also received regarding the location of the mobile terminal.

The received channel condition and location information are stored in a repository. The serving base station accesses data in the repository to determine if the mobile terminal would have improved connectivity if it handed over to a neighbour base station, and, when such a determination is affirmative, it sends a recommendation to the mobile terminal to handover to the other base station. The channel condition and location data store may be located in the base station. The data store content may be generated by a request response mechanism in reply to the base station. On the whole, Handover is a concept in Mobile Communication Networks to facilitate seamless connectivity which is the ability of a mobile user to maintain connectivity with the network without any QoS degradation for ongoing application's sessions.

2. MOTIVATION AND REVIEW OF RELATED WORKS

Several researchers have studied the performance of soft handover on CDMA systems. They also attempt to solve problems using different models. Research on the tradeoffs and parameter settings are mostly in the form of simulation studies. Nevertheless, a case where a User Equipment (UE) is moving at a high speed from one cell area to another cell area was considered. In such cases, it is possible that the UE has moved into the new cell area before handover is completed at the BS side. This may lead to call dropping. This call dropping can be attributed to handover delay. Handover delay in wireless networks is induced by mainly four components, namely:

- 1) Time taken to send measurement procedures by the source BS to the UE,
- 2) Time taken by the UE to obtain the measurements from adjacent BSs and send the measurement reports to the source BS
- 3) Time taken by the source BS to identify the target BS and
- 4) Time taken to transfer the UE session from source BS to target BS.

The motivation for this work has risen from the fact that most of the UE movements follow a mobility pattern over a long period of time. In such case, user movement behaviour can be predicted using the mobility pattern. If the user movement behaviour can be predicted:

- The network may proactively start the handover procedure and thereby minimize the handover delay thus reducing call dropping,
- The source BS may pro-actively communicate with the target BS to ensure enough resources are there to support the UE without degrading the QoS.

Prediction of user movement has been suggested as an effective method to reduce handover delay [2]. A prediction technique is proposed in [13], which uses simple moving average and simple mobility pattern matching. The impact of incorporating handover prediction information into the call admission is studied in [14]. Although these models were helpful at showing that soft handover has some trade margin gain over hard handover and that there is a possible uplink capacity increase in power controlled systems with hard handover, they are however limited comparisons which do not adequately balance the main advantages and disadvantages of soft handover.

When the soft handover concept was formally introduced for IS-95 systems, a lot of researches followed. Most research publications came under three broad categories:

- (i) Evaluation of soft handover performance through the assessment of link level indicators such as the average E_0/I_0 and fade margin improvement for individual radio links [16].
- (ii) Using system level indicators for estimating the performance of soft handover. The possible indicators could be related to the QoS such as outage probability, call blocking probability and handover failure rate for a given load or related to the system optimization parameters such as capacity and coverage gain for a given QoS requirement [3].
- (iii) Investigation of soft handover based on resource efficiency indicators or adaptive techniques such as the mean active set number, active set update rate and handover delay time [18].

In most other works, the establishment of appropriate thresholds and solution to call overlap was a major concern. In [12] a report on the performance analysis of soft handover algorithm proposed in the IS-95 CDMA standard is presented. They also present a simulation that enhanced the selection of appropriate handover thresholds. An improved soft handover control that solves the call overlapping problem by contracting the soft handover region was proposed in [9]. The extent of contradiction was determined by considering the amount of other cell interference and the rate of traffic congestion simultaneously. Through proposed numerical models, they conclude that hot-spot cell's performance could be improved through handover reduction. An extensive study of soft handover effects on the downlink of WCDMA networks was done in [4]. The author provides a new method of optimizing soft handover that maximizes the downlink capacity with a new power control approach. A focus on the effects of soft handover applied to a realistically planned UMTS network is made in [8]. They evaluate the interference mitigation and capacity loss tradeoffs using dynamic simulation. The effect of soft handover techniques on cell coverage on reverse link capacity is investigated in [3]. The authors show that soft handover significantly increases both parameters relatively to conventional handovers.

A focus on the effects of soft handoff applied to a realistically planned UMTS network is made in [7]. They evaluate the interference mitigation and capacity loss tradeoffs using dynamic simulation. The effect of soft handoff techniques on cell coverage on reverse link capacity is investigated in [17]. The authors show that soft handoff significantly increases both parameters relatively to conventional handoffs. To the best of our knowledge, existing literature on the soft handoff problem constitutes a body of analytical evidence, which does not adapt proposed models to practical environments. The importance of this paper is not only to make data publicly available for future research, but to present a concise and working methodology that can be built on and enhance effective academia-industry collaborations.

Mostly, research works on call dropping which have a direct bearing with handover performance have progressed steadily over the years. Nasser [11] have proposed a dynamic adaptation framework which provide an acceptable tradeoff between new call blocking and handoff call dropping probability in cellular based multimedia wireless network. The framework takes advantage of the adaptive bandwidth access, enhance system utilization and blocking probability of new calls.

The knowledge of call dropping behaviour as a function of network parameters (example traffic load and call duration) can help operators to optimize performance and improve the QoS, as well as revenue. In [13], an effective admission control scheme to solve handoff probability has been proposed. Their scheme is based on the estimation of call dropping probability and estimates the call dropping probability of the cell where a new exist and accepts the call only when the estimated probability does not exceed a certain threshold value set in advance. Unfortunately, they do not consider multiple access and handoff control. In realistic environment, the request of call and its response are performed with control packets which contend with one another and compromise effective band allocation.

3. SYSTEM ARCHITECTURE

The practical realization of handoff in a cellular communication network required architectural representation. The fundamental issue is that each cell is assigned a list of potential target cells, which can be used for handing-off call session from this source cell to the relevant target cells. The architectural illustration of handover process can be simplified into three phases:

- Measurement phase
- Decision phase
- Execution phase

In the **measurement phase**, the necessary information needed to make the handover decision is measured. Typical downlink measurements performed by the mobile are the E_c/I_0 of the Common Pilot Channel (CPICH) of its serving cell and neighbouring cells. For certain types of handover, other measurements are needed. The relative timing information between the cells needs to be measured in order to adjust the transmission timing in soft handover to allow coherent combination of received signals from the Rake receiver. In the **decision phase**, the criterion for determining the fulfilment of handoff process is established. Absolutely, the **execution phase** help in finishing handoff process and updating relative parameters. Figure 1 shows our proposed mobile communication system architecture.

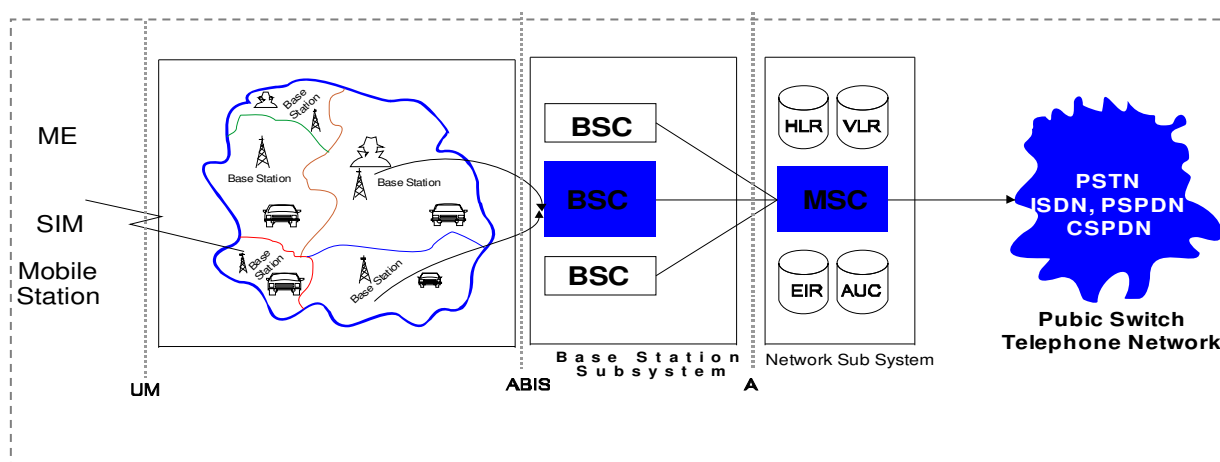

Fig. 1: Proposed Mobile Communication System Architecture

3.1 Description of the Components of the Architecture

The various components of the proposed architecture are described as follows:

1. Mobile equipment (ME) and subscribers identification module (SIM) constitutes the mobile station.
2. The components of the mobile station MS are located within the cellular region (cellular sub-systems).
3. The mobile stations continuously listen to a common channel of the network on order to register a call.
4. Contains monitoring of communication between the mobile and Bs verifies the quality and detests the need for a cell transfer.
5. BSC and radio transmitter/receiver by which the mobile station and connected to the wire-line network.
6. By primary rate digital connections (base station sub-system and network sub-system)
7. The MSc acts as local exchange in the fixed network and keeps tracks of the subscriber's location with the help of location register.

Basically, during the connection, the User Equipment (UE) continuously measures some items concerning the neighbouring cells and reports the status of these items to the network up to the RNC. These items are measured from the neighbouring cells Pilot Channels (PICHs). The RNC checks whether the values indicated in the measurement reports trigger any criteria set. If they trigger, the new BS is added to the active set.

4. MODEL DESCRIPTION AND FORMULATION

Consider two overlapping cells, **cell-1** and **cell-2**, where the shape of each cell is circular, for simplicity. Also, both cells may be of the same size or different sizes. Figure 2 shows a simplified Cellular System Model. The overlap region represents the soft handoff region (a transition area where soft handoff occur), and calls within this region are connected to at least two base stations. Calls in the non-overlapping region (also called the hard region) are connected to only one base station. An efficient handoff scheme should ensure that calls are allocated a free channel in the hard region (HR) and two channels in the soft region (SR), where one of the channels would service the mobile on transit and the other assigned at the point of successful handshake. On successful handshake, the handoff scheme should disengage one of the channels, after an acknowledgment is received and the mobile enters the neighbouring cell and the call is finally dropped.

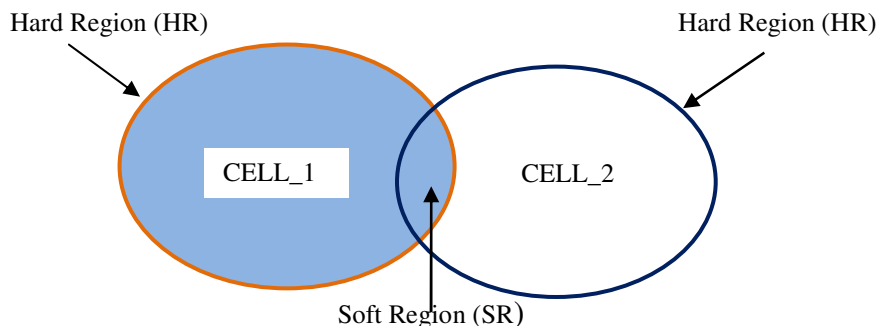

Fig. 2: Simplified Cellular System Model, Source: [15]

First, we define the events in the study environment as follows:

- A*, be the event that a call is successfully admitted on handoff
- B*, be the event that a call is blocked
- C*, be the event that there is congestion
- D*, be the event that a call is dropped

However, in this paper, three factors have been clearly identified as major factors impairing the successful handoff of mobile calls in the existing system. We define these factors as follows: Let

- B, the event of call blocking
- C, the event of call congestion
- D, the event of call dropping

Now, let SH represent a successful call handoff. This even therefore is mutually exclusive of three factors defined above (*i.e.*, **B**, **C**, and **D**), and using *set theory* we define Successful call Handoff (SH) as:

$$SH = B^c \text{ and } C^c \text{ and } D^c \quad (1)$$

Where,

B^c represents a no call blocking event

C^c represents a no call congestion event

D^c represents a no call dropping event

and B^c , C^c and D^c are all independent events, that is,

$$SH = B^c \cap C^c \cap D^c \quad \text{or}$$

$$P(SH) = P(B^c) \cdot P(C^c) \cdot P(D^c) \quad (2)$$

Nevertheless,

$P(B^c) = 1 - P(B)$, and $P(B)$, the call blocking probability is given as the Erlang B formula [1], that is,

$$P(B) = \frac{\frac{\rho^{nc}}{nc!}}{\sum_{i=1}^{nc} \frac{\rho^i}{i!}} \quad (3)$$

Where nc , is the number of channels
 ρ , is the traffic intensity

Similarly,

$P(C^c) = 1 - P(C)$, which is directly proportional to traffic [10], thus,

$$P(C) = k \cdot \rho \quad (4)$$

where

k is a constant

ρ is the traffic intensity

Also, $P(D^c) = 1 - P(D)$ which is given in [9],

$$P(D) = \frac{(d_r t)^n}{n!} \rho^{-d_r t} \quad (5)$$

Where

d_r is the drop calls rate

t is the call duration

n is the number of dropped calls

$P(C)$ and $P(D)$, are the call congestion and call dropping probabilities respectively.

Therefore, applying probabilities, we obtain:

$$P(SH) = [1 - P(B)][1 - P(C)][1 - P(D)] \quad (6)$$

Precisely, simplifying equation (6), we derive:

$$P(SH) = 1 - [P(B) + P(C) + P(D)] + P(B)P(C) + P(B)P(D) + P(C)P(D) - P(B) \cdot P(C) \cdot P(D) \quad (7)$$

By substitution, equations (4) and (5) in equation (7) we obtain,

$$\begin{aligned} P(SH) &= 1 - \left(\frac{\rho^{nc}}{nc!} + K\rho + \frac{(d_r t)^n}{n!} e^{-d_r t} \right) + \frac{\rho^{nc}/nc!}{\sum_{i=0}^{nc} \left(\frac{\rho^i}{i!} \right)} \cdot K\rho \\ &+ \frac{\rho^{nc}/nc!}{\sum_{i=0}^{nc} \left(\frac{\rho^i}{i!} \right)} \cdot \frac{(d_r t)^n}{n!} \rho^{-d_r t} + K\rho \cdot \frac{(d_r t)^n}{n!} \cdot \rho^{-d_r t} - \frac{k\rho \cdot \rho^{nc}/nc!}{\sum_{i=0}^{nc} \left(\frac{\rho^i}{i!} \right)} \cdot \frac{(d_r t)^n}{n!} \cdot \rho^{-d_r t} \\ &= 1 - \left(\frac{k\rho^{1+nc} (d_r t)^n e^{-d_r t}}{nc! n! \sum_{i=0}^{nc} \left(\frac{\rho^i}{i!} \right)} \right) - \left(\frac{\rho^{nc}}{nc! \sum_{i=0}^{nc} \left(\frac{\rho^i}{i!} \right)} + \frac{(d_r t)^n}{n!} e^{-d_r t} + k\rho \right) \\ &+ \left(\frac{k\rho^{1+nc}}{nc! \sum_{i=0}^{nc} \left(\frac{\rho^i}{i!} \right)} \right) + K\rho \cdot \frac{(d_r t)^n}{n!} e^{-d_r t} + \frac{\rho^{nc} (d_r t)^n e^{-d_r t}}{n! nc! \sum_{i=0}^{nc} \left(\frac{\rho^i}{i!} \right)} \end{aligned} \quad (8)$$

Hence, Simplifying equation (8), yields

$$\begin{aligned} P(SH) &= 1 - \left(\frac{k\rho^{1+nc} (d_r t)^n}{nc! n! \sum_{i=0}^{nc} \left(\frac{\rho^i}{i!} \right)} e^{-d_r t} \right) - \left(\frac{\rho^{nc}/nc!}{\sum_{i=0}^{nc} \left(\frac{\rho^i}{i!} \right)} + \frac{(d_r t)^n}{n!} e^{-d_r t} + k\rho \right) \\ &+ \frac{k\rho^{1+nc}/nc!}{\sum_{i=0}^{nc} \left(\frac{\rho^i}{i!} \right)} + \frac{k\rho (d_r t)^n}{n!} e^{-d_r t} + \frac{\rho^{nc} (d_r t)^n}{n! \sum_{i=0}^{nc} \left(\frac{\rho^i}{i!} \right)} e^{-d_r t} \end{aligned} \quad (9)$$

Equation (9) represents our Soft Handover Performance probability model and is simulated and discussed in the next section.

5. CASE STUDY ANALYSIS

Analysis of Existing System

In the existing system (Airtel Nigeria), the rate at which calls are caused to wait due to channel un-accessibility is very high. To assess the performance of SHO in the system, we shall study the behavioural pattern of the system parameters that contribute to altering the state of the system. Figure 3 shows a graph of call block rate (%) at different BSCs for a period of 2 weeks in two months. It is a representation of the analysis of the existing system. The network was not stable over the study period as the blocking rate often exceeds the definite threshold value. This variation could be attributed to the limited cell capacity and internal configuration settings of the network, which may result in blocking, congestion, channel allocation problem, network failure and co-channel interference. Hence, network operators should maintain good configuration settings and monitor their cell capacity to ensure that the congestion, call drop and block rate of their network is negligible and not beyond the preset threshold of 0.01 as may be required. Here the average call blocking rate is viewed as a function of base stations and number of days.

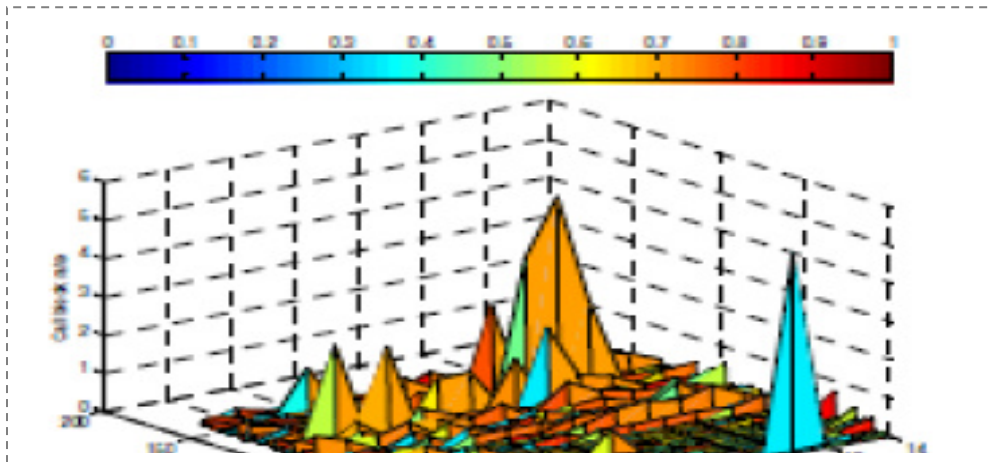

Fig. 3. A graph of Call Soft Handoff at different BSCs for a period of investigation

Table 1: Empirical Soft Handoff Field Data Analysis

Days	Day 1	Day 2	Day 3	Day 4	Day 5	Day 6	Day 7	Day 8	Day 9	Day 10	Day 11	Day 12	Day 13	Day 14
Dropped Calls	0.504	1.169	0.714	0.18	0.502	0.443	0.187	0.561	0	0.254	0.68	1.46	0.208	0.5
Congested	0	0	0	0.06	0.397	0.564	0.124	0	0	0.137	0	0.06	0	0.05
Blocked Calls	14	0	2	1	10	17	3	1	3	25	25	74	38	15
Days	1	2	3	4	5	6	7	8	9	10	11	12	13	14

Figure 4 reveals that call blocking increased more than acceptable state and this is adverse of a network whose aim is to satisfy her clients with Good Quality of Service (QoS). Nevertheless, we further observed that call blocking is not significantly influenced by the number of base stations (i.e. $R^2=0.0427$). Therefore network operators should explore more vibrant alternatives to solving network inconvenience since appropriate options are essentially available to optimizing any vulnerable network system. Figure 5 shows a graph of call block rate (not in %) at different BSCs for a period of 2 weeks in three months.

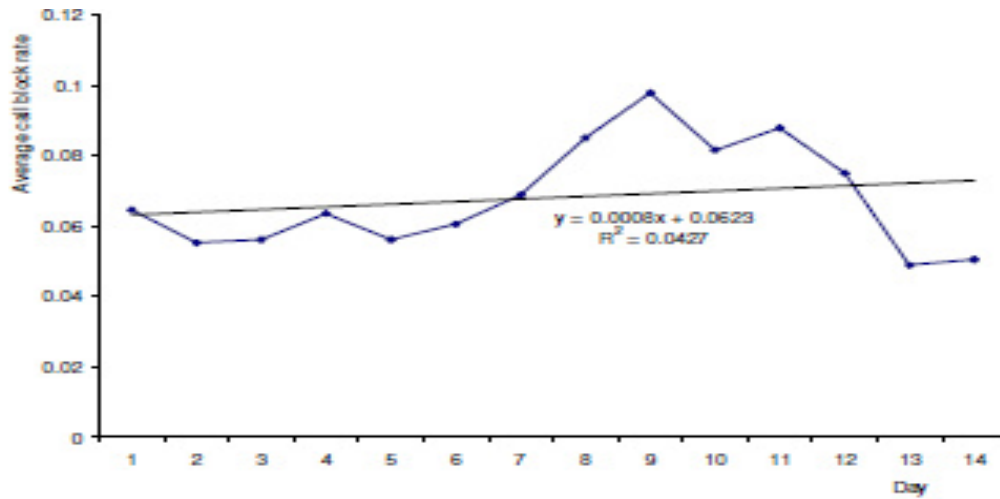

Fig 4: A graph of call block rate (%) at different BSCs for a period of 2 weeks in three months

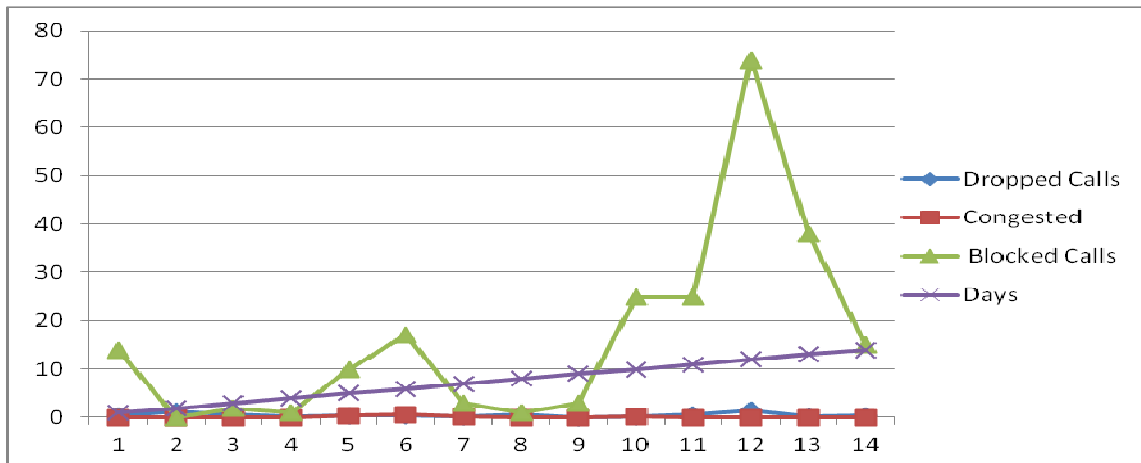

Fig. 5: A graph of call block rate (not in %) at different BSCs for a period of 2 weeks in three months

5.1 Empirical Soft Handoff Field Data Analysis

In this paper, several data have been collected for four months from the Airtel Nigeria network: from March to June, 2013. These data sets were related to several GSM traffic cells, for a total of about 300,000 monitored calls, chosen as a representative sample to obtain numerically considerable data. The relative sample significance is defined in terms of cell extension, number of served subscribers in the region, and traffic load; for this basis, macro GSM cells in an urban metropolitan environment were selected. The software tool (I-manager) utilizes the Clear Codes reported in the databases of the cellular network operator; calls are classified in dropped, blocked and congested, distinguishing for the former the causes of handoff success rate. By observing the Dropped, blocked and congested calls, and the difference between their derivatives, it is possible to evaluate the distribution of the Handoff process, which we refer to as Handoff performance. Statistical analysis of the measured data was carried out, allowing us the estimation of network Quality of Service (GoS).

Table 1 shows empirical soft handoff field data analysis. Tables 5 Shows the various sample input parameters and their respective values for **investigating: data rate, stepsize constant, call duration, and number of channels** for the various system environments under study. These parameters are standard but the values may vary. These parameter's values enables the simulation of the model in order to determine the handover performance of a cellular communications networks.

Table 2: Sample Input Parameters and Their Respective Investigating Data Rate for the Various System Environments Under Study

S/N	PARAMETERS	VALUE
1.	Lower Bound	1
2.	Upper bound	10
3.	Stepsize	0.1
4.	Traffic Intensity	0.2, 0.2, 2
5.	No. of Channels	7
6.	Data Rate	128, 256, 1024
7.	Call Duration	2
8.	No. of Users (Subscribers)	10

Table 3: Sample Input Parameters and their Respective Investigating Stepsize Constant for the Various System Environments Under Study

S/N	PARAMETERS	VALUE
1.	Lower Bound	1
2.	Upper bound	10
3.	Stepsize	0.1, 0.2, 0.3, 0.4
4.	Traffic Intensity	0.2, 0.2, 2
5.	No. of Channels	7
6.	Data Rate	1024
7.	Call Duration	2
8.	No. of Users (Subscribers)	10

Table 4: Sample Input Parameters and their Respective Investigating Call Duration for the Various System Environments Under Study

S/N	PARAMETERS	VALUE
1.	Lower Bound	1
2.	Upper bound	10
3.	Stepsize	Stepsize that produced the highest PSH traffic intensity
4.	Traffic Intensity	0.2, 0.2, 2
5.	No. of Channels	7
6.	Data Rate	1024
7.	Call Duration	2, 5, 10
8.	No. of Users (Subscribers)	10

Table 5: Sample Input Parameters and their Respective Investigating No. of Channels for the Various System Environments Under Study

S/N	PARAMETERS	VALUE
1.	Lower Bound	1
2.	Upper bound	10
3.	Stepsize	0.1
4.	Traffic Intensity	0.2, 0.2, 2
5.	No. of Channels	2, 4, 8
6.	Data Rate	1024
7.	Call Duration	10
8.	No. of Users (Subscribers)	10

6. MODEL SIMULATION / RESULTS

Figures 6 - 9 are simulated graphs obtained from our model using Matlab. Figure 6 shows graph of Handoff Success Rate (HSR) vs. Traffic Intensity at various data rate ($dr = 128, 256, 1024$). Figure 7 shows graph of Handoff Success Rate (HSR) vs. Traffic Intensity at various stepsize ($K = 0.1, 0.2, 0.3, 0.4$). Figure 8 shows graph of Handoff Success Rate (HSR) vs. Traffic Intensity at the highest step size $k=0.1$. Figure 9 shows graph of Handoff Success Rate (HSR) vs. Traffic Intensity at the various number of channels ($nc = 2, 4, 8$).

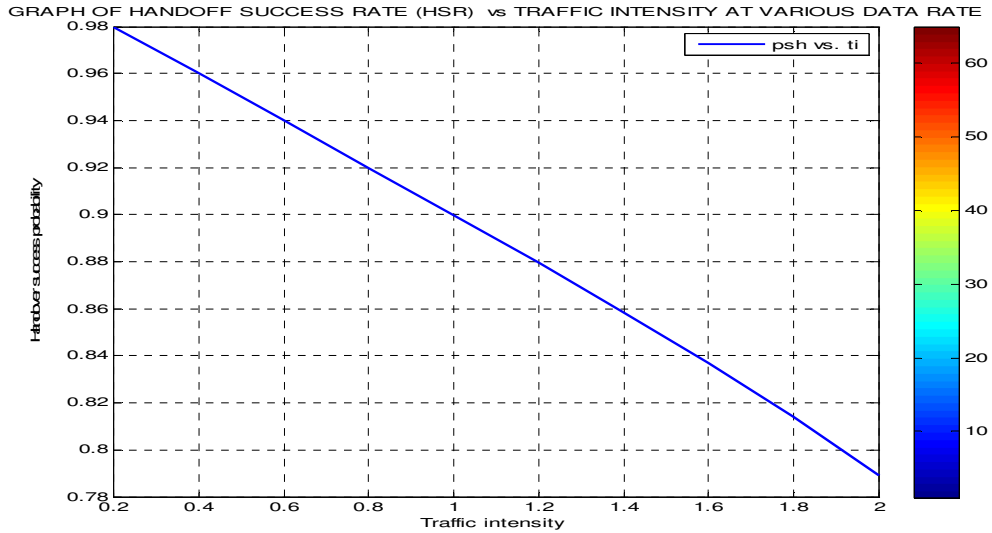

Fig. 6: Graph of Handoff Success Rate (HSR) vs. Traffic Intensity at various data rate ($dr = 128, 256, 1024$)

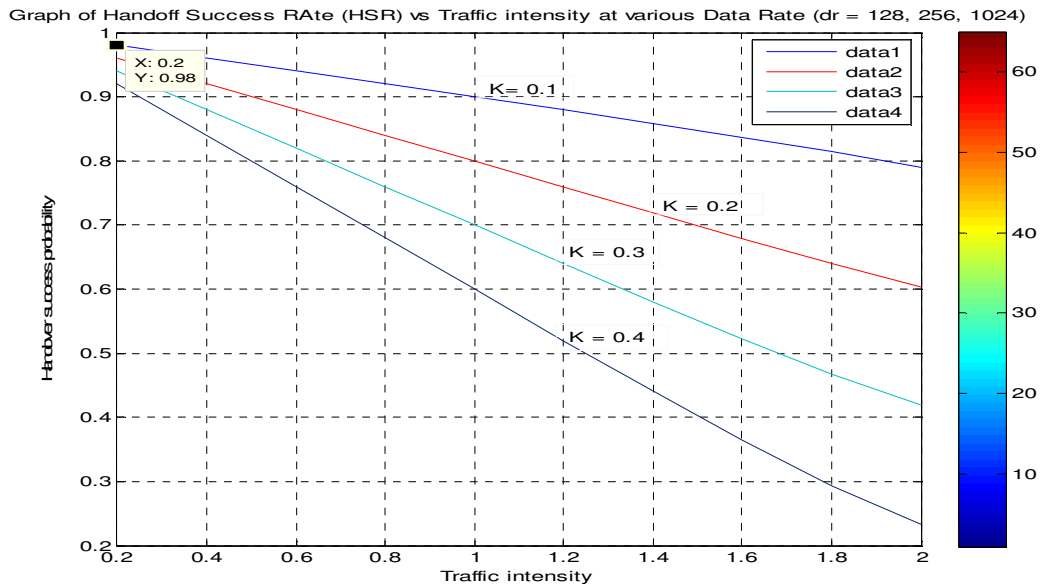

Fig. 7: Graph of Handoff Success Rate (HSR) vs. Traffic Intensity at various stepsize ($K = 0.1, 0.2, 0.3, 0.4$)

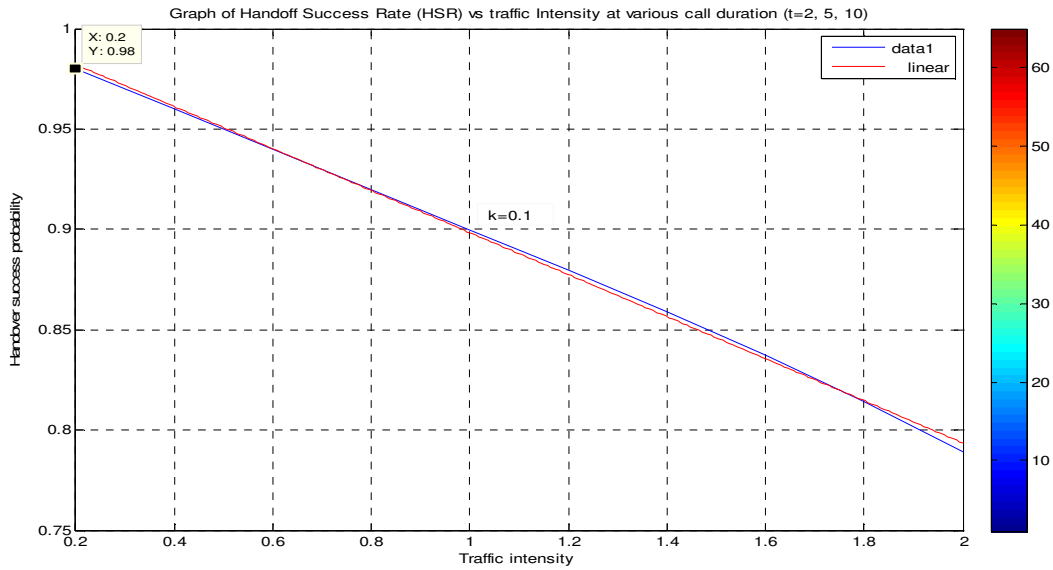

Fig.8: Graph of Handoff Success Rate (HSR) vs. Traffic Intensity at the highest step size $k=0.1$

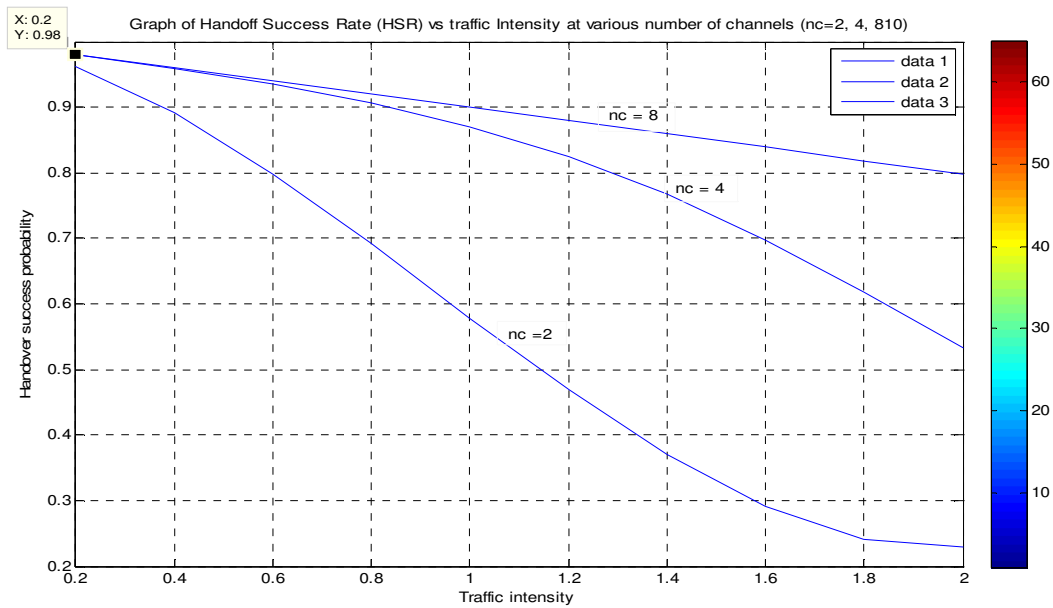

Fig. 9: Graph of Handoff Success Rate (HSR) vs. Traffic Intensity at the various no. of channels ($nc = 2, 4, 8$)

6.1 Discussion of Results

Figure 6 and 7 shows the effect of SHO on varying traffic intensity. We investigate the effect of traffic intensity on the handoff success probability on different data rates. We observed that as the traffic intensity increases, more calls are dropped by the system and increase in data rate does not have any effect on the system. This scenario is typical of a base station with limited channels capacity servicing much traffic. This call for allocation of more channels to enable the system copes with increasing traffic. In practice, network operators are not likely to experience severe network crises if the system capacity is not sufficient to accommodate the frequent rise in traffic.

Figure 8 shows the effect of traffic intensity on handoff success rate at various stepsize (k). It is observed that, the network performance deteriorates with increasing step size. At $K=0.1$, we obtain an optimal performance, as the model is capable of minimizing the rate of congestion. Therefore, minimizing the frequency of congestion is likely to enhance the performance of the existing system and this can be achieved by controlling the stepsize constant.

Figure 9 shows that at optimal stepsize, K , mobile users can make longer calls with higher data rates without degrading the systems performance. However, with more channels assignment as shown in figure 9, the rate of handoff greatly improves. Realistically, network operators require sufficient channel capacity to minimize handoff failure rates in the system. With insufficient channel allocation ($n_c = 2$), the curve falls steeply (that is, the network degrade faster) it assumes stability from a traffic intensity of 1.8, compared to $n_c=4$ and $n_c=8$. With more channel allocation, there is confident that the system could be effectively fine tuned for optimal performance.

Generally, there is a proportional increase in growth across the respective environments. Therefore, network operators should maintain a minimum SH threshold for different propagation environment (or deployments) to avert the detrimental effect of running into undesirable states that could cause system malfunctioning. From our investigations, we discovered that network site engineers were unfamiliar with the soft handover concept and how to deal with problems associated with it. This explains why the network degrades longer than expected without due attention. The neglect in turn affects the subscribers and negatively impact on the system's performance.

Furthermore, it is evident that network systems could perform optimally in free-space than in other environments. The notion is true given the nature of impairments that tend to obstruct the line of site in other propagation environments. In practice, cellular network operators should not site base stations among obstacles, but use effective strategies to circumvent obstacles and observe a free-space broadcast. Our model controls the likelihood of a system going into indeterminate states (rising above a SH probability of 1), as experienced in the existing system in Figures 3 and 4. Generally, it has been analyzed theoretically and mathematically that capacity depends on the size of the overlapping area between adjacent cells, the numbers of channels per cells and distribution of traffic. The higher the overlapping area, the higher the trucking efficiency gain(s). The overlapping area can be used to reduce the call blocking and dropping probabilities. The attractive feature is that the research has helped establish a practical solution using handover manageability models to improve the performance of soft handoffs in CDMA networks without increase in the system complexity. At last, the implementation of mathematical models as mentioned in the research have a greater contribution in call handoff, QoS's and grade of service.



7. CONCLUSION

Soft handoff is an interesting technology. It promises better performance than hard handoff. In this research, we have analyzed the performance of soft handoff in a realistic cellular network and revealed the problems associated with soft handoffs in telecommunication systems. We have also proposed a SH model, implementing same using realistic data for the purpose of improving the performance of the system, taking into consideration different coverage areas and diverse propagation exponents. The research has helped establish a practical solution using mathematical models that improves the performance of soft handoffs in CDMA networks. We have focused on the establishment of soft handoff threshold values that are appropriate for urban, suburban, rural, and free space communities. Managing handover and performance shall offer best practices to network operators and telecommunication industries.



REFERENCES

- [1] Angus, L. (2001). Introduction to Erlang B & C, Tele Management Magazine, Canada.
- [2] [Martinez-Bauset, J.](#) ; [Gimenez-guzman, J.](#); [Pla, V.](#) (2008), Optimal Admission Control in Multimedia Mobile Networks with Handover Prediction, IEEE Wireless Communications vol. 15, issue 5, pp. 38-44.
- [3] Chen, W., Liu, J. and Huang, H. (2004).: An Adaptive Scheme for Vertical Handover in Wireless Overlay Networks. In: Proc. of International Conference on Parallel and Distributed Systems (ICPADS), Newport Beach, CA, IEEE Press,
- [4] Ekici, E. (1997). Optimal Two-Tier Cellular Network Design, BS Dissertation, Bogazici University, Turkey.
- [5] Ekpenyong, M., Isabona, J. and Umoren, I. (2012). On the Estimation Capacity of Equal Gain Diversity Scheme Under Multi-path Fading Channel, In Proceedings of Fourth International Conference on Network and Communications.
- [6] Ekpenyong, M. and Umoren, I. (2012): QoS-Aware SINR-based Call Blocking Evaluation in Cellular Networks with 3G Interface
- [7] Freeman, R. L., (1999). Fundamentals of Telecommunications, New York: John Wiley & Sons.
- [8] Forkel, I (2005). Performance Evaluation of the UMTS Terrestrial Radio Access Modes, Ph.D Dissertation Aachen University, ABMT 48, p. 292, ISBN: 3-86130-177-6, Wissenschaftsverlag Mainz.
- [9] Garg, P., and Goyal, N. (2006). Blocking Performance Enhancement Using Congestion Control in Optical Burst Switching Networks
- [10] Lee [Dong-Jun](#) and Cho [Dong-Ho](#) (1999). Soft handoff initiation control in CDMA cellular system [Vehicular Technology Conference., VTC 1999 - Fall. IEEE VTS 50th](#), Volume: 4 Taejon, South Korea
- [11] Nasser, N., Hasswa, A. and Hassanein, H. (2006). Handovers in Fourth Generation Heterogeneous Networks, IEEE Communications Magazine, vol. 44, pp. 96-103.
- [12] Kim, J. S., Chung, M. Y. and Shin, D. R. (2005). A Vertical Handover Algorithm Based on Context Information in CDMA-WLAN Integrated Networks. In: Proc. of International Conference on Computational Science and Its Applications (ICCSA). LNCS, vol. 3480, Springer, Heidelberg, pp. 348-358.
- [13] Shigeki, S. and Michihiro, I. (2002). Call Admission Scheme Based on Estimation of Call Dropping Probability in Wireless Networks.
- [14] Tarkaa, N. S., Mon, J. M. and Ani, C. J. (2011). Drop Call Probability Factor in cellular Networks. International Journal of Scientific and Engineering Research 2(10): 1-5.
- [15] Umoren, I, Asagba, P. O. and Owolabi, O. (2013). Evaluating Handover Performance in Mobile Communication Networks, MicroWave, International Journal of Science & Technology, Vol.5 No.1, pp. 3-12.
- [16] Vicent, P. (2006). Optimal Admission Control Using Handover Prediction in Mobile Cellular Networks, Latin America Transactions, IEEE (Revista IEEE America Latina) Volume 4, Issue 6, Dec. pp. 436 - 442.
- [17] Viterbi, A. and Viterbi, A., (1993). Erlang Capacity of A Power Controlled CDMA System, IEEE Journal on Selected Areas of Communication, Vol. 11, pp. 892-900.
- [18] Yang, Z., Liu, Z., Chen Z. and Yaun, Z. (2007). Adaptive Synchronization of an Uncertain Complex Delayed Dynamical Networks, *International Journal of Nonlinear Science*. 3 (2), 125-132 Conference (WCNC), Atlanta, GA, IEEE Press